

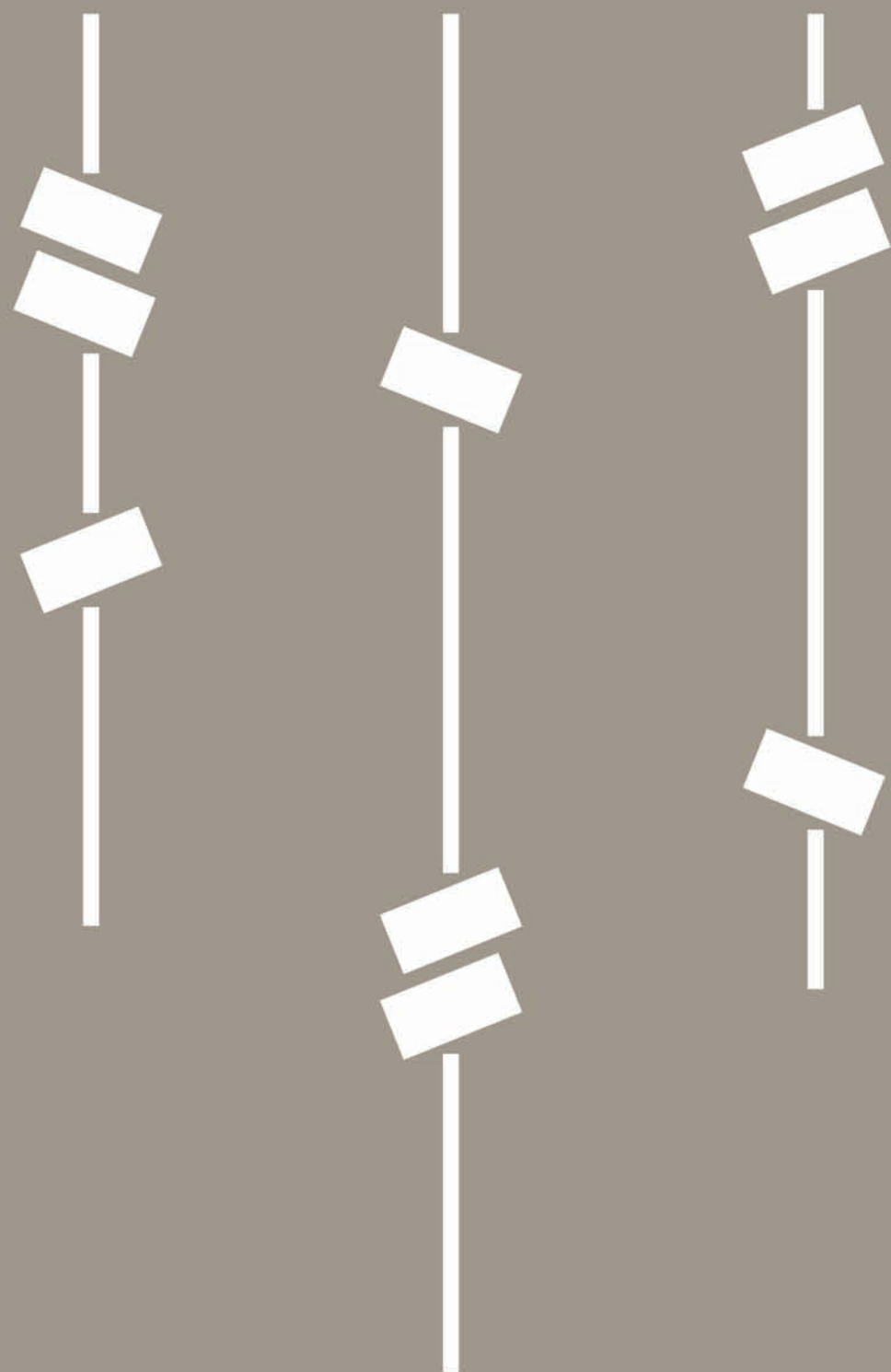

simon
LIGHT UP EMOTIONS

西蒙电气(中国)有限公司
SIMON ELECTRIC (CHINA) CO., LTD.
办公地址: 上海市闵行区申长路988弄虹桥万科中心1号楼5层
邮编: 201106 电话: 86-21-38552222 传真: 86-21-38552200
<http://www.simon.com.cn> E-mail: market@simon.com.cn

DR0PSC 01 2021年01月 印 图片素材: shuner stock图片有限公司



simon

485200071 2021.01

FLUVIA | Drop

FLUVIA

光的艺术，空间的格调



Design Simon

FLUVIA 系列是 Simon 西蒙电气建筑艺术照明领域的经典代表，多次获得 iF 产品设计奖、红点设计大奖、Plus X Award 奖等国际大奖。

FLUVIA 赋予建筑个性的设计理念，以极具吸引力和创新性的设计语言，唤醒用户情绪，创建多种室内光场景。

FLUVIA is a classic of Simon in architectural lighting and has won international awards such as IF Award, Red Dot Award, Plus X Award.

FLUVIA endows architect with unique design concept and arouse emotions in people with multiple scenarios created by its appealing and innovative design.



Inspiration & Creation

人与空间密不可分，而光是营造空间氛围的重要元素。

依托建筑，烘托空间，利用灯光营造空间的整体氛围。在空间中自由组合的照明形式和丰富的灯光效果，颠覆了人们对室内照明的概念，赋予每个空间以独特的个性。

FLUVIA 结合建筑语言，为空间的格调增添创造力与想象力。

Man cannot live without space where light is important in creating atmosphere. Light is used to create atmosphere in spaces and highlight architects. Lighting design and light combination can endow each space with uniqueness, which has change people's idea about interior lighting.

Together with architect, FLUVIA add innovative and imaginative elements to spaces.



D R O P

Drop

点缀,彰显细节。

Drop 通过万向调节装置可调转至任意方向。光点洒落在不同的平面上,在有限的空间里创造生动活泼的光影艺术,满足客户所需。







紧凑型设计

通过专业和创新的连接系统,使我们能够精减模块体积,从而创造出更卓越的照明产品。



万向调节

万向调节装置可将光源模组 360° 旋转, 投射出不同的光束。



定制光线

射灯模组可单独控制及调节光线，可根据投影距离和所需效果进行精准调整。
支持OBD、DALI调光。

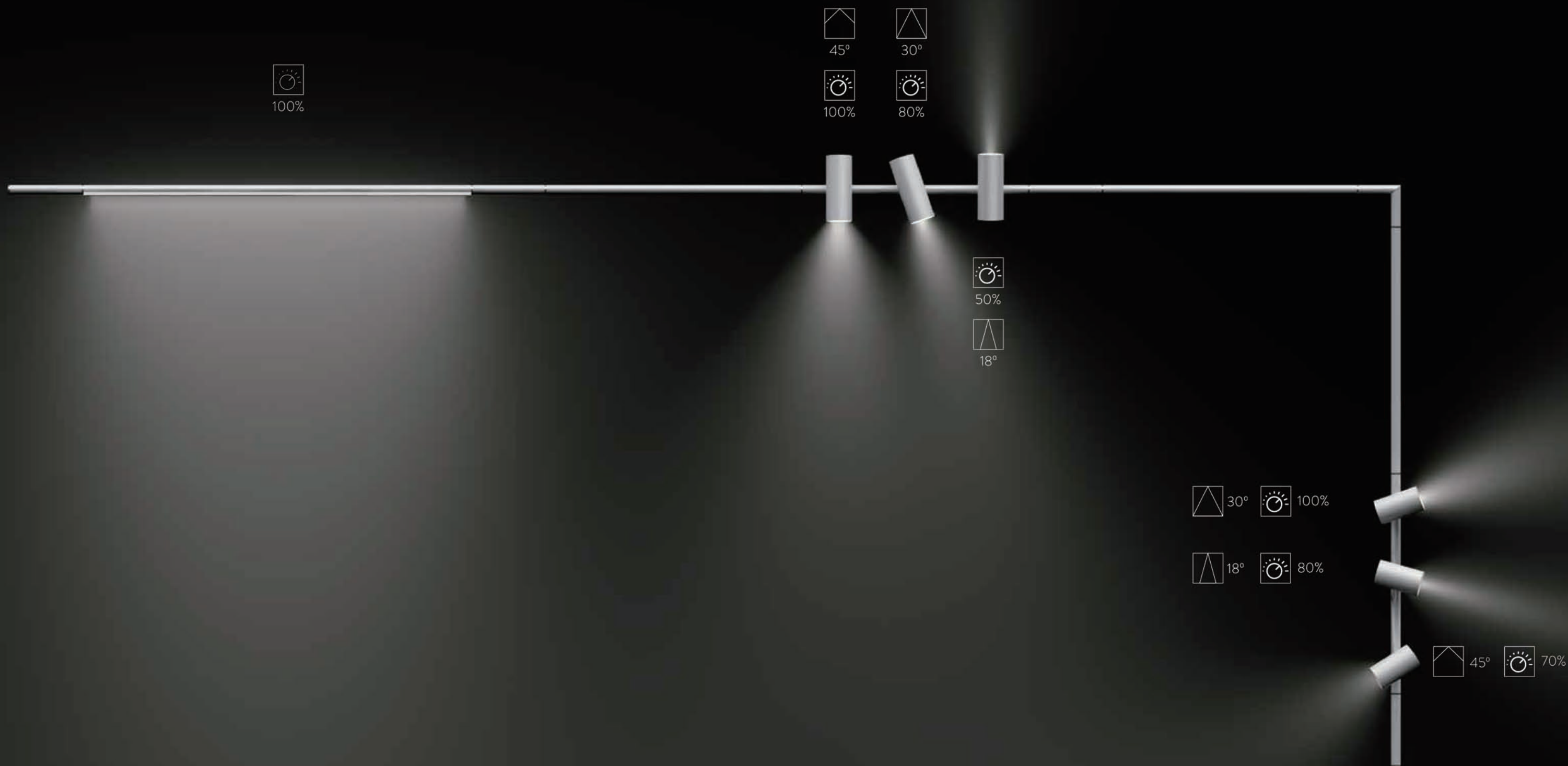

自由集成

Drop 集成于 Slim System 的自由组合结构,通过连接设计将各种照明光源结合,并把光线送达多样化区域和空间,使其能满足不同所需。



- 2700K ● 3000K
- 4000K

光模块

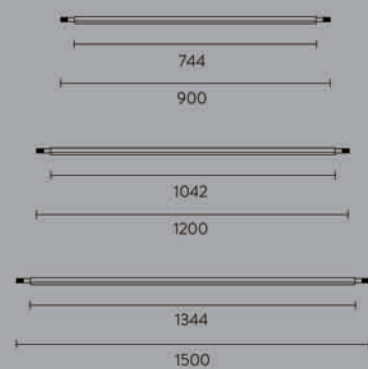

连接杆



Drop Mini

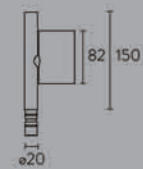

Drop

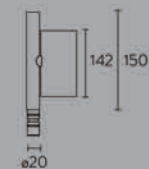

配件

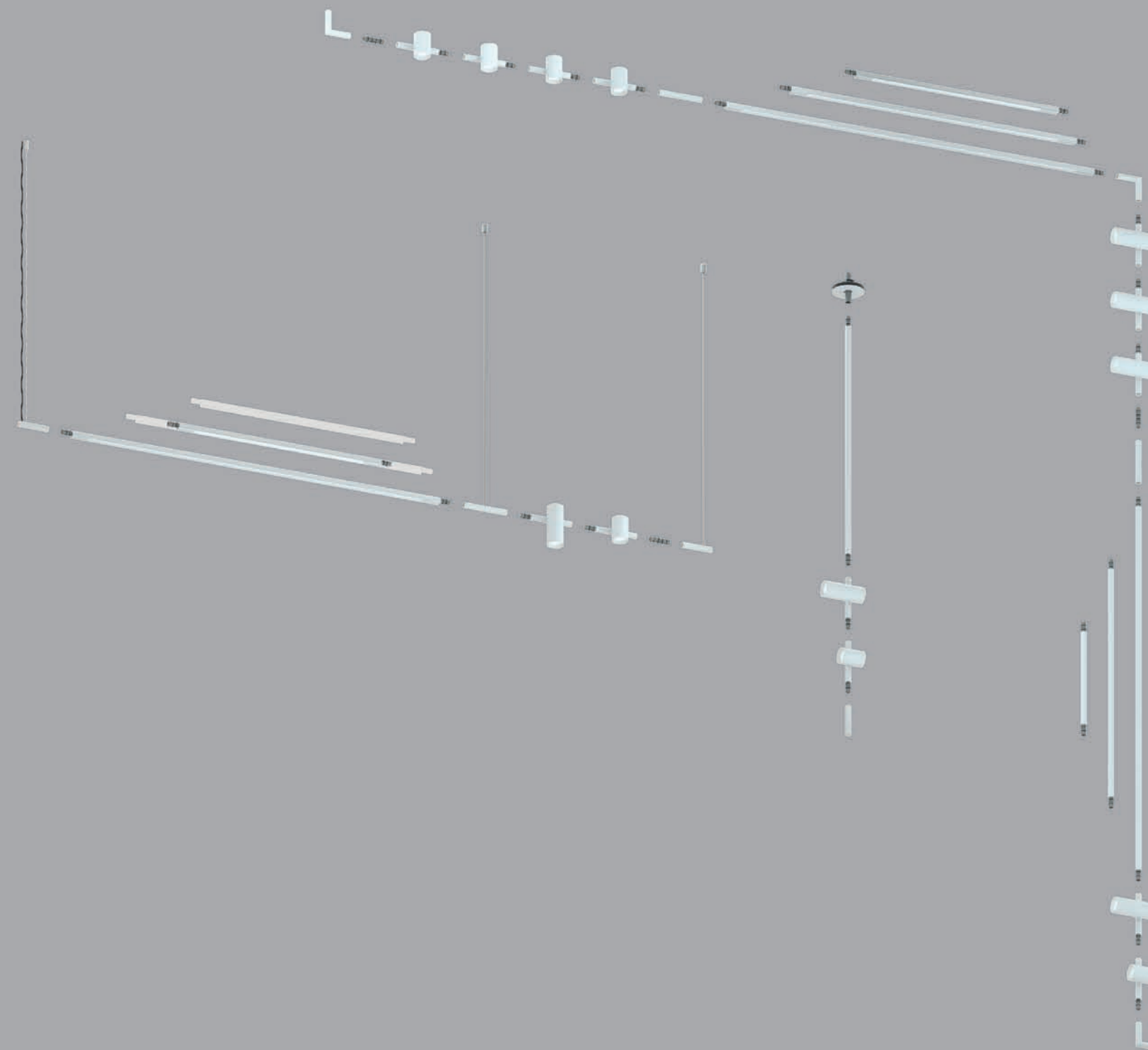
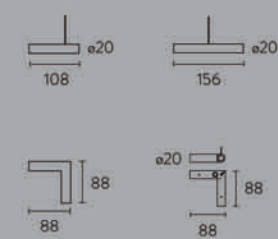

灯体颜色





D R O P

安装方式	悬挂式	显色性	Ra90
功率	13.5W,20W	可调角度	355°
光束角	18° ,30° ,45°	控制方式	On Board Dimmer, DALI
光通量	945lm-1600lm	IP	20
色温	2700K,3000K,4000K	使用电压	48VDC
色容差	SDCM < 3		

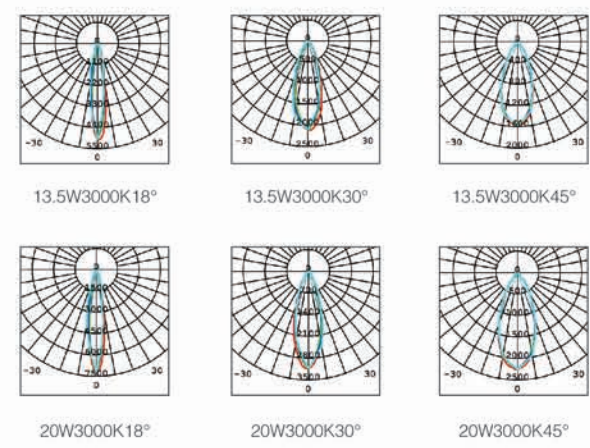

DROP

配件

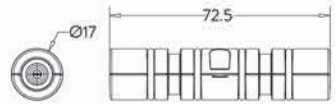

代码	名称	产品尺寸
N6424-0502	DROP 过线连接配件 (OBD)	Ø17×72
N6424-0504	DROP 过线连接配件 (DALI)	Ø17×72

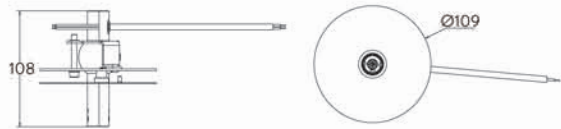

代码	名称	产品尺寸	安装方式	灯体颜色
N6424-0483	白色 DROP 射灯无边框安装配件 (OBD)	Ø109×108	嵌入式	白色
N6424-0503	白色 DROP 射灯无边框安装配件 (DALI)	Ø109×108	嵌入式	白色
N6424-0505	黑色 DROP 射灯无边框安装配件 (OBD)	Ø109×108	嵌入式	黑色
N6424-0506	黑色 DROP 射灯无边框安装配件 (DALI)	Ø109×108	嵌入式	黑色



Drop 匹配 Slim System 安装注意事项

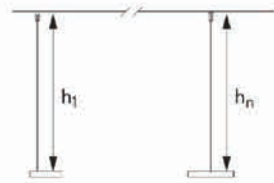

$$h_1 = h_n$$

保证吊索高度一致

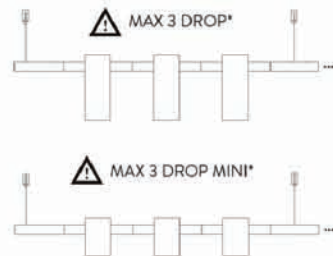

单独 Drop 串接, 数量不能超过 3 个

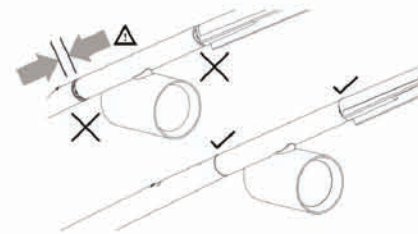

连接处需紧密插入, 不能留空隙, 易造成接触不良

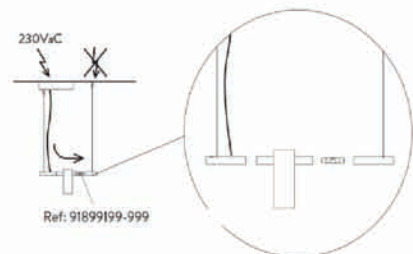

使用厂家配件包内六角扳手进行螺丝旋紧, 切不可用电动钻头, 容易造成滑牙

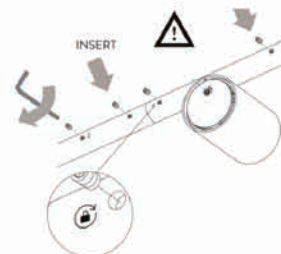

Drop 与 end 端端头需加连接件连接

